

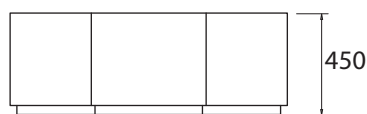

Module A

Module B

Module C

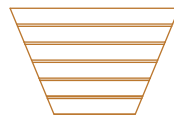
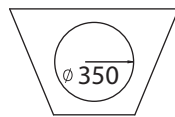
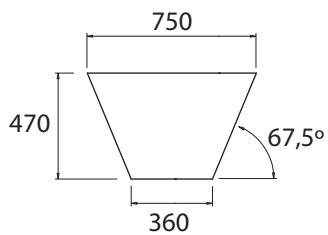
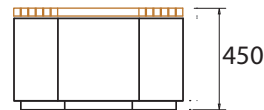
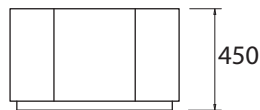
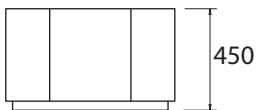

Module D

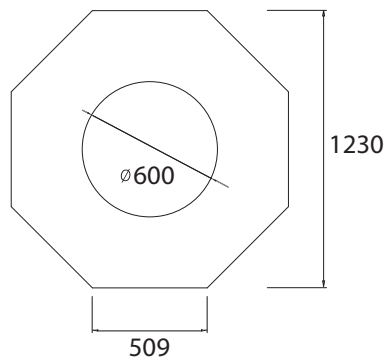

Banquette COROIBO

Description

Module A, B et D en granit scié.
Module C en granit scié et assise en bois
d'Iroko traité.
Système de fixation: simplement posé.

Dimensions

Module A,B,C: 750x470x450 mm.
Module D: 1230x1230x450 mm.

Poids

Module A: 306 Kgs.
Module B: 204 Kgs.
Module C: 282 Kgs.
Module D: 1.062 Kgs.